



TAWEESAP 2559 CO., LTD

2025 COMPANY PROFILE

METAL PART MANUFACTURING



www.taweessap2559.com

Table of Contents

Introduction	03
Mission and Vision	04
Our Services	05
Milestones	06
Certificate	06
Machine List	07
LITZ LU-620	08
Machining Center	09
TAKISAWA NX-2000YS	10
HANWHA XE35	11
CNC Turning Lathe	12
CMM Mitutoyo	13
Measurement	14-15
Sample Work	16-19
Raw Materials	20
Production Line	21
Training	22
CSR	23
Contact us	24

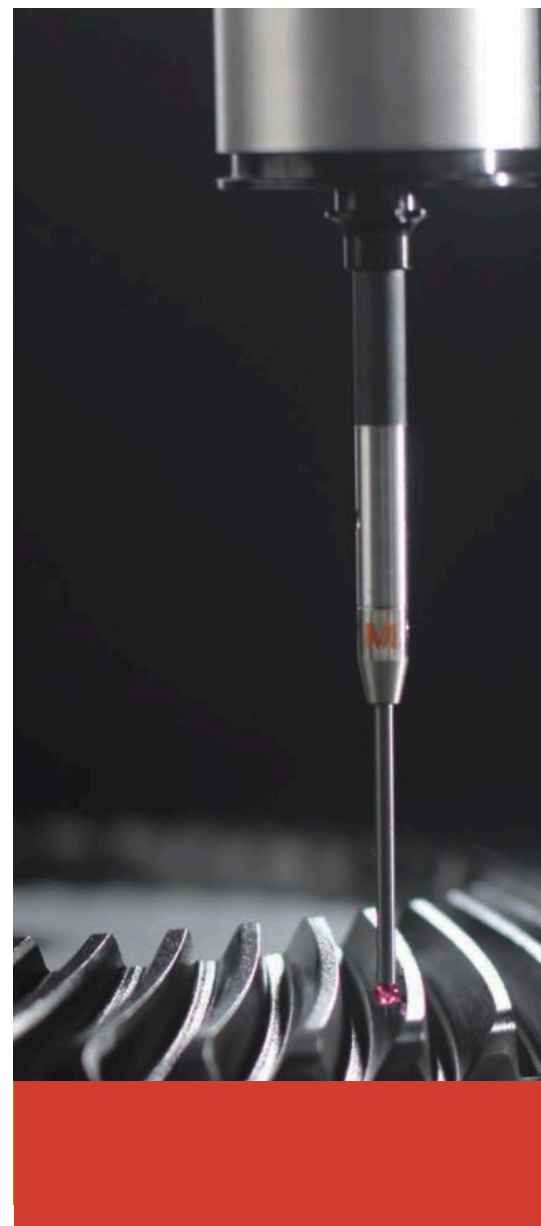

Introduction

Consulting services and produce metal parts By experts in lathe work, milling work, milling, drilling, mild steel, grade steel, copper, brass, stainless steel, aluminum, and others. Guaranteed quality of work both quickly and quickly. Make large metal pieces, milling work, cutting work, various drilling work, produce electronic parts. Produce machine spare parts automotive parts Produce workpieces according to drawings or samples. Supports all types of industrial production work with modern machinery CNC Machining Center, CNC Lathe, CNC Auto Lathe and standardized measuring instruments



Thepchai Nilnuanl
Managing Director



Wattanachai Phetcharachai
General Manger

Mr. Thepchai Nilnuan has opened a metal parts factory. Support the production of quality parts for customers. By adhering to the goal of "building confidence and maximum satisfaction for customers" with more than 7 years of expert experience in the industry.

Mission and Vision

→ Mission

Respond to the needs of customers as well. Production of high-quality work By modern machinery-technology Through the professional skills and abilities of the employees Ready to continuously develop and improve Enhance the quality of working life for employees and look for partners to increase business opportunities

→ Vision

We are lead of manufacture high end spare part from metal part. There for customer satisfaction, Team happy, Stable and recognized in the Industrial.

P

P = Planning

L

L = Learning

U

U = Understand
ing

S

S = Safety

Our Services



-
- Produce metal parts using CNC machines
-
- Turning of automotive spare parts
-
- Produce Mold Die Part, Produce Spare Parts
-
- Turning work, Jig Fixture production
-
- Milling work, gear milling work,
-
- Produce work pieces according to the drawing.

Milestones

2016	2017	2023	2024
Taweessap 2559 Start up	Install CNC and Lath Machine	Successful Certified 9001:2015, Install Litz Machine 5 Axis, Install Travel 2000 Series 5 Axis	Install New CRYSTA APEX Machine (CMM)

Certificate

Taweessap2559 are manufacture metal parts by experts in CNC lathe work, milling work Biting and drilling with experience. We have expertise in producing a wide variety of custom metal work. Format according to customer needs and successful in Certified ISO9001:2015.



Machine List

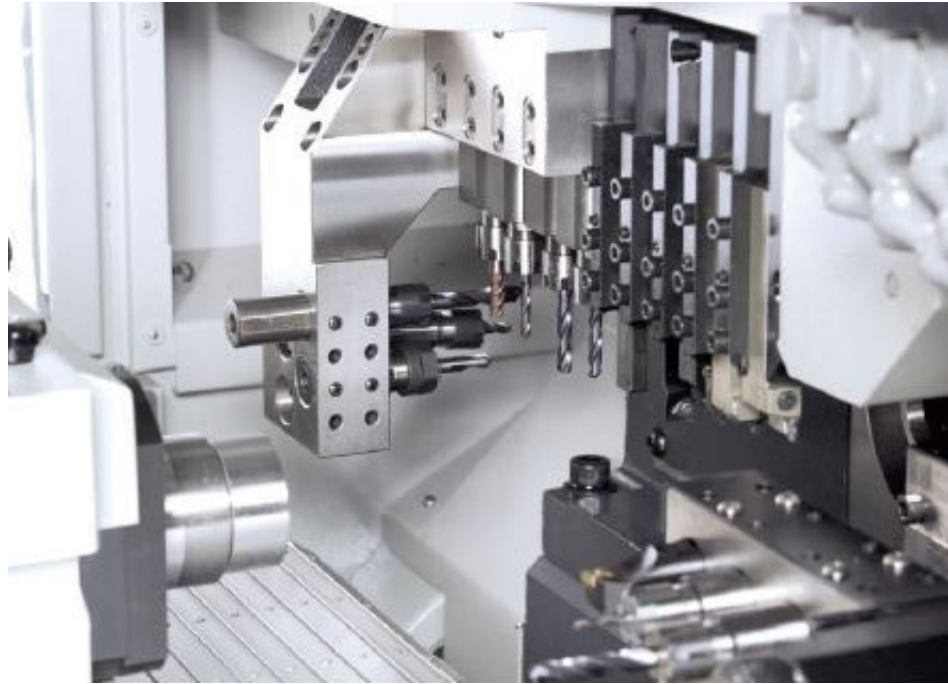

- 01** — CNC Machining Center # 13 Unit
- 02** — CNC Machining Lathe # 13 Unit
- 03** — Milling Machine # 1 Unit
- 04** — Manual Machining Lathe # 2 Unit
- 05** — CNC Machining Lathe Barfeed # 2 Unit



LITZ LU-620 Travel For 5-Axis

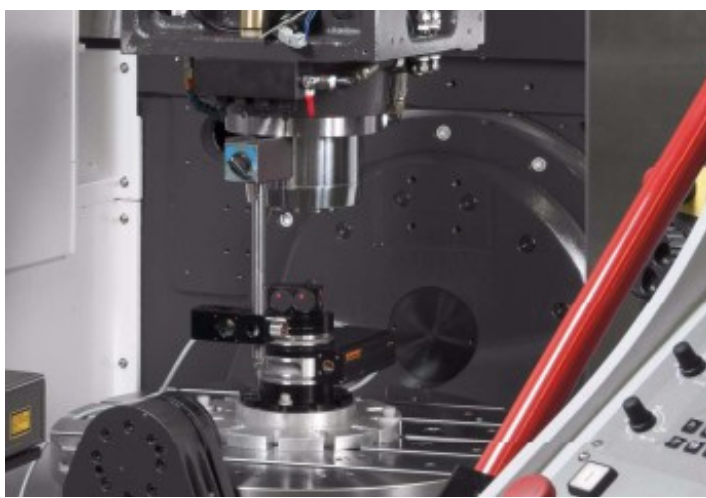
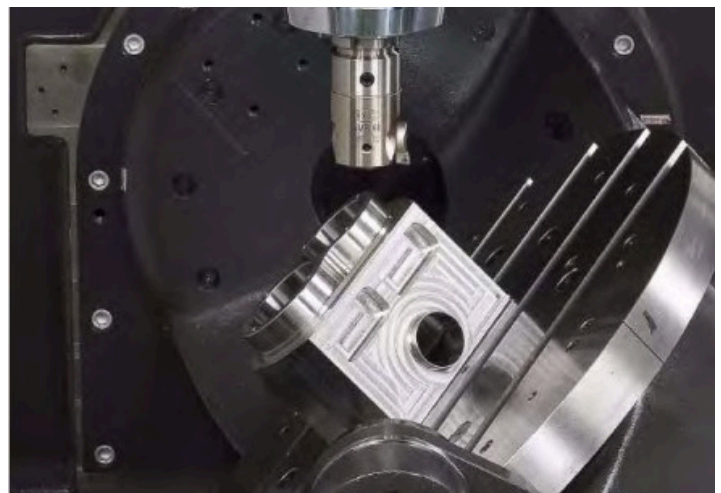

Machining Center



**LITZ DM 800 Travel
for 3-Axis**



**LITZ DM 1000
Travel For 4-Axis**



Victor Vcenter-F76



Victor Vcenter-102



**Fanuc Japan Model
: Mate T 10**



SAMSOM SMV-1050



SAMSOM SMV-1568

TAKISAWA NX-2000YS Series Travel for 5-Axis

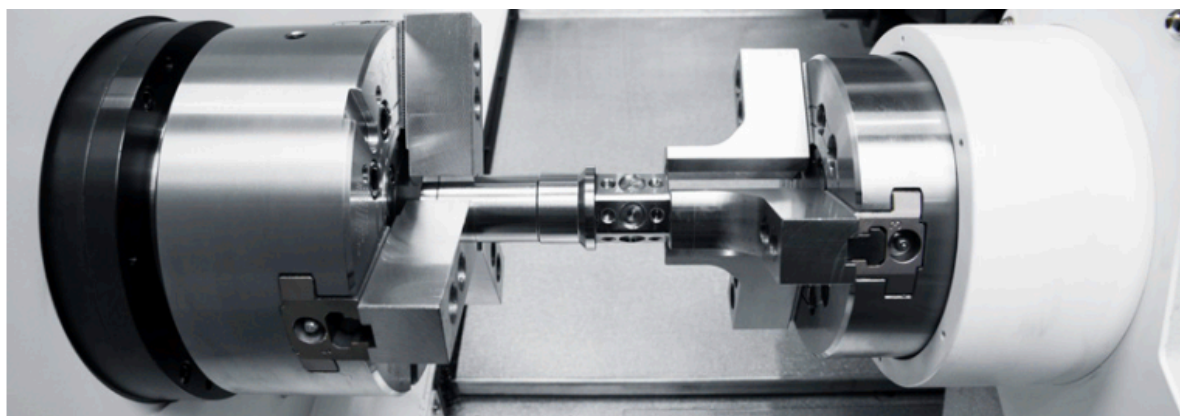

HANWHA XE35 Series Travel for 5-Axis

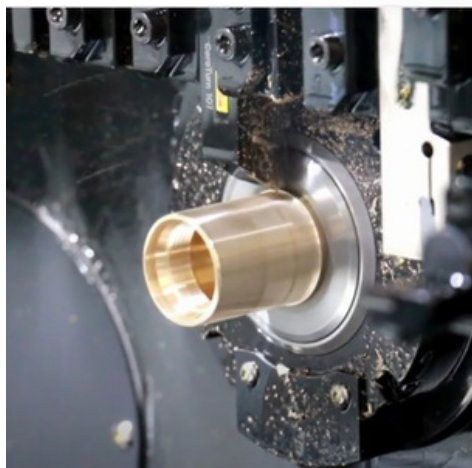
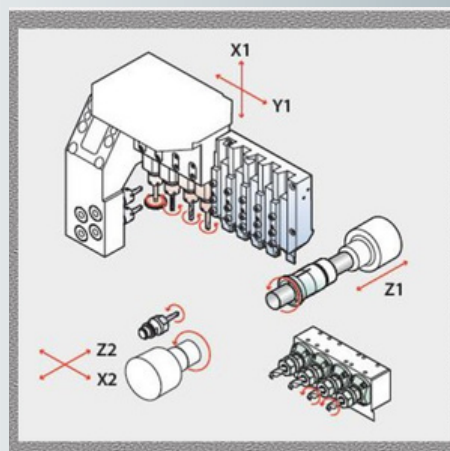

CNC Turning Lathe



Victor Vturn P16



Victor Vturn P20



TAKISAWA NEX-105



MIYANO LX-01



TAKAMAZ X-10



**BAR FEEDER CITIZEN
CINCOM M20**

CMM Mitutoyo CRYSTA-Apex V574

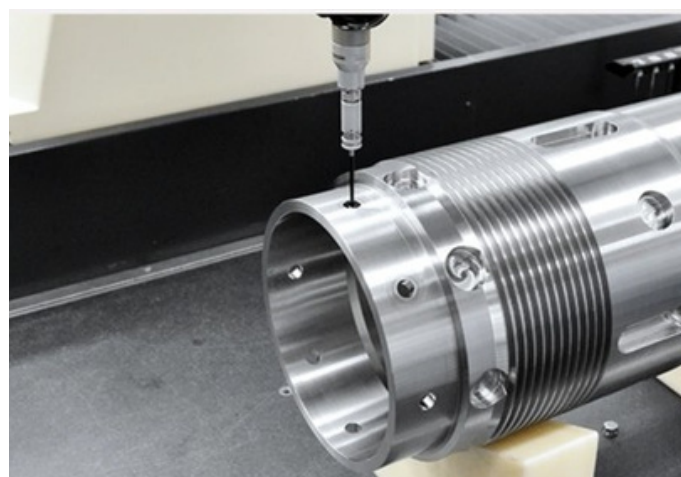
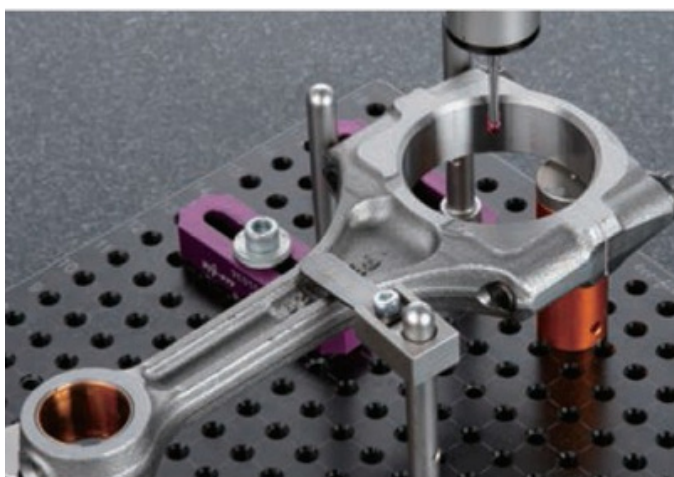

Measurement Machine & Equipment



Plug Thread Gauge



Digimatic Bore Gages



Height Gauge



Dernier Digital



Micrometer Digital



Surface Roughness Tester



**Profile
Measuring Microscope**



Pin Gauge



Digimatic Indicator



Ring Thread Gauge



Dial Bore Gauge

Measurement Machine & Equipment



We pay attention to every production step.
Until checking the size of the workpiece to meet the design with standard measuring tools.
Focusing mainly on quality work and customer satisfaction

Sample Work Of CNC Auto Lathe

NO.				
Material	ATL001	ATL002	ATL003	ATL004
	SUS304	SUS304	PEEK1000	SUS304
NO.				
Material	ATL005	ATL006	ATL007	ATL008
	SUS304	SUS304	SUS304	SUS304
NO.				
Material	ATL009	ATL010	ATL011	ATL012
	SUS304	BRASS	S45C	SUS304
NO.				
Material	ATL013	ATL014	ATL015	ATL016
	SUS304	BRASS	SUS304	SUS304
NO.				
Material	ATL017	ATL018	ATL019	ATL020
	SUS304	SUS304	SUS304	SUS304
NO.				
Material	ATL021	ATL022	ATL023	ATL024
	SUS304	SUS304	SUS304	SUS304
NO.				
Material	ATL025	ATL026	ATL027	ATL028
	SUS304	SUS304	SUS304	BRASS

Sample Work Of CNC Lathe

<p>NO. Material</p>	 <p>L001 BRASS</p>	 <p>L002 SUS304</p>	 <p>L003 BRASS</p>	 <p>L004 POM</p>
<p>NO. Material</p>	 <p>L005 SUS304</p>	 <p>L006 SUS304</p>	 <p>L007 BRASS</p>	 <p>L008 FOAM</p>
<p>NO. Material</p>	 <p>L009 SUS304</p>	 <p>L010 S45C</p>	 <p>L011 AL6061</p>	 <p>L012 AL5056</p>
<p>NO. Material</p>	 <p>L013 AL6061</p>	 <p>L014 SUS440C</p>	 <p>L015 S45C</p>	 <p>L016 POM</p>
<p>NO. Material</p>	 <p>L017 AL6061</p>	 <p>L018 POM</p>	 <p>L019 SUS304</p>	 <p>L020 AL6061</p>
<p>NO. Material</p>	 <p>L021 AL6061</p>	 <p>L022 AL6061</p>	 <p>L023 AL6061</p>	 <p>L024 AL6061</p>
<p>NO. Material</p>	 <p>L025 AL6061</p>	 <p>L026 AL6061</p>	 <p>L027 AL6061</p>	 <p>L028 AL6061</p>

Sample Work Of CNC Lathe+CNC Machining

<p>NO.</p> <p>Material</p>	 <p>LM017</p> <p>SUS304</p>	 <p>LM018</p> <p>FOAM</p>	 <p>LM019</p> <p>FOAM</p>	 <p>LM020</p> <p>AL6061</p>
<p>NO.</p> <p>Material</p>	 <p>LM021</p> <p>SUS304</p>	 <p>LM022</p> <p>SUS304</p>	 <p>LM023</p> <p>SUS304</p>	 <p>LM024</p> <p>S45C</p>
<p>NO.</p> <p>Material</p>	 <p>LM025</p> <p>BRASS</p>	 <p>LM026</p> <p>S45C</p>	 <p>LM027</p> <p>S45C</p>	 <p>LM028</p> <p>AL6061</p>
<p>NO.</p> <p>Material</p>	 <p>LM029</p> <p>SUS304</p>	 <p>LM030</p> <p>S45C</p>	 <p>LM031</p> <p>S45C</p>	 <p>LM032</p> <p>S45C</p>
<p>NO.</p> <p>Material</p>	 <p>LM033</p> <p>AL6061</p>	 <p>LM034</p> <p>AL6061</p>	 <p>LM035</p> <p>AL6061</p>	 <p>LM036</p> <p>AL6061</p>
<p>NO.</p> <p>Material</p>	 <p>LM037</p> <p>BRASS</p>	 <p>LM038</p> <p>AL6061</p>	 <p>LM039</p> <p>AL6061</p>	 <p>LM040</p> <p>SUS304</p>
<p>NO.</p> <p>Material</p>	 <p>LM041</p> <p>SUS304</p>	 <p>LM042</p> <p>S45C</p>	 <p>LM043</p> <p>S45C</p>	 <p>LM044</p> <p>SS400</p>

Sample Work Of CNC Machining Center

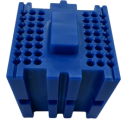

M001

NYLON

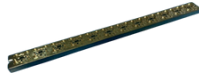

M002

SUS304

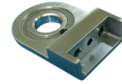

M003

AL6061

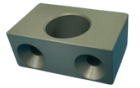

M004

AL6061



M005

AL6061



M006

AL6061

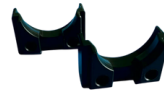

M007

AL6061

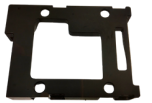

M008

AL6061



M009

AL6061



M010

AL6061



M011

SUS304



M012

SUS304

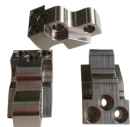

M013

SUS304



M014

SUS304



M015

SUS304



M016

AL6061



M017

PEEK1000



M018

S45C



M019

S45C



M020

SKD11

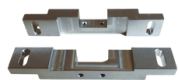

M021

AL6061



M022

AL6061



M023

AL6061



M024

AL5083



M025

AL5083



M026

AL6061



M027

AL6061



M028

AL6061

Raw Materials

ALUMINUM TYPE

ALUMINUM 5052, 5056, 5083, 6061, 6063, 7075

STAINLESS TYPE

SUS303, SUS304, SUS316, SUS316L, SUS440C

STEEL TYPE

SS400, S45C, SCM435, SCM440, SKD11, DC53

PLASTIC TYPE

POM, DELRIN, PE1000,TEFLON,ACRYLIC

Production Line



Training

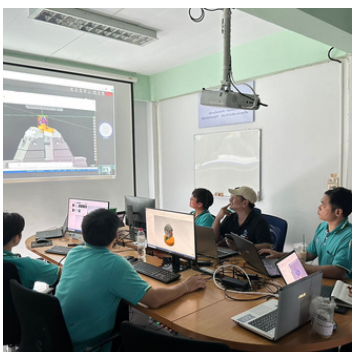

We has training for engineers and technicians to increase their ability in solutions.

Upgrading techniques and employees to increase operational potential and support production that will increase To meet the needs of various customers.

CSR





Contact us

Phone

(662) 010 6906
(666) 575 24001

Address

22/71,22/72 Moo. 13 Khlong Song,
khlong Luang, Pathumthani 12120



COMPANY MAP

Email

taweesap2559.co.ltd@gmail.com

Social



WEBSITE



FACEBOOK

Sales department

 (668) 199 54419
K.Wattanachai Pechrachai



LINE QR CODE

TAWEE SAP

22/71,22/72 Moo. 13 Khlong Song,
Khlong Luang, Pathumthani 12120
(662) 010 6906
(666) 575 24001

METAL PART MANUFACTURING

2025